

Pfaff 294  
Subclass  
May 1987



CSMP

Unterklassen-Ausstattung

Subclass parts

Composition des sous-classes

Composición de las subclases



CSMP

Unterklassen-Ausstattung 1)  
 Equipement des sous-classes 1)

Subclass organization 1)  
 Dotación de las subclases 1)

Unterklasse Subclass Sous-classe Subclase	Ausführung Model Version Tipo de maquina	Nadelabstand in mm Needle gauge in mm Ecartement des aiguilles en mm Distancias entre agujas en mm	Nadelhalter, 102 Needle holder Pince-aiguille Portaaguas	Nadelstangenrohr Needle bar tube Tubo de la barra de aguja	Nadelstange, 102 Needle bar Barre à aiguille Barra de aguja	Stoffschieber, 101, 102 Feed dog Griffe Transportador inferior	Stichplatte, 101, 102 Needle plate Plaque à aiguille Placa de aguja
-72/01-944/01	B	1,2 - 2,8	91-118 195-93 x 3,2*	91-140 099-05	91-715 538-93 <u>30/01</u>	91-047 025-04	91-048 212-03 <u>5</u>
	B	3,2 - 4,8	91-119 309-93	91-140 099-05	91-740 235-93 <u>30/01</u>	91-047 025-04	91-048 212-03 <u>5</u>
-72/02-944/01	A	1,2 - 1,6	91-018 165-93		91-140 642-93	91-047 025-04	91-048 508-04
	B	2,0 - 2,8					
	B	3,2 - 6,0					
-72/02-944/01-900/56	A	1,2 - 1,6	91-018 165-93		91-140 642-93	91-059 210-04	91-158 173-04
	B	2,0 - 2,8					
-72/02-944/01	B/CN	2,4 - 2,8	91-018 165-93		91-140 642-93	91-059 210-04	91-158 626-04
	B/CN	3,2 - 6,0	91-018 166-93		91-140 644-93	91-059 210-04	91-158 626-04
-72/02-944/01-900/56	B/CN	2,4 - 2,8	91-018 165-93		91-140 642-93	91-059 210-04	91-158 174-04
	B/CN	3,2 - 6,0	91-018 166-93		91-140 644-93	91-059 210-04	91-158 174-04
-750/01-4/01	A	0,8 - 2,2	91-118 195-93 x 2,4*	91-140 099-05		91-040 358-04	91-048 068-04
	B	1,2 - 2,2					
	B	2,4 - 2,8					
-750/01-4/01-900/56	B	2,4 - 2,8	91-118 195-93 x 3,2*	91-140 099-05		91-040 358-04	91-048 068-04
	B	3,2 - 6,0	91-119 309-93	91-140 099-05		91-040 358-04	91-048 068-04
	A	0,8 - 2,2	91-118 195-93 x 2,4*	91-140 099-05		91-059 210-04	91-158 168-04
B	1,4 - 2,2						
-750/01-4/01-900/56	A; B	2,4 - 6,0	91-119 309-93	91-140 099-05		91-059 210-04	91-158 173-04
	CN	1,2 - 6,0	91-118 195-93 x 2,4*		91-140 099-05	91-059 210-04	91-158 172-04
			<u>10</u> = 1,2 - 2,2 mm	91-158 170-04			
<u>10</u> = 2,4 - 6,0 mm			91-158 174-04				
							<u>10</u> = 1,6 - 2,4 mm
							<u>10</u> = 2,8 - 6,0 mm
-944/01	A	0,8 - 2,2	91-118 195-93 x 2,4*	91-140 099-05	91-715 538-93 <u>30/01</u>	91-040 358-04	91-048 068-04
	B	1,2 - 2,2					
	B	2,4 + 2,8					
-944/01-900/56	B	2,4 + 2,8	91-118 195-93 x 3,2*	91-140 099-05	91-715 538-93 <u>30/01</u>	91-040 358-04	91-048 068-04
	B	3,2 - 6,0	91-119 309-93	91-140 099-05	91-740 235-93 <u>30/01</u>	91-040 358-04	91-048 068-04
	A	0,8 - 2,2	91-118 195-93 x 2,4	91-140 099-05		91-059 210-04	91-158 168-04
B	1,4 - 2,2						
-944/01-900/56	A; B	2,4 - 6,0	91-119 309-93	91-140 099-05		91-059 210-04	91-158 173-04
	CN	1,2 - 6,0	91-118 195-93 x 2,4*		91-140 099-05	91-059 210-04	91-158 172-04
			<u>10</u> = 1,2 - 2,2 mm	91-158 170-04			
<u>10</u> = 2,4 - 6,0 mm			91-158 174-04				
							<u>10</u> = 1,6 - 2,4 mm
							<u>10</u> = 2,8 - 6,0 mm

1) Die Liste enthält nur Nähwerkzeuge. Beim Umbau in eine andere Ausführung sind auch noch Maschinenteile erforderlich. Geben Sie also bei Bestellungen die genaue Bezeichnung der vorhandenen und der gewünschten Ausführung bekannt.

1) This list contains sewing parts only. When converting to another version, machine parts are also necessary. Therefore when ordering please indicate exactly the existing version and the one required.

1) Cette liste ne contient que les organes de couture. En cas de transformation en une variante différente, il faut utiliser aussi certaines pièces de machine supplémentaires. En cas de commande, prière de toujours indiquer par conséquent les variantes disponibles et souhaitées.

1) Esta lista sólo contiene elementos de costura. Siempre que haya que transformar la maquina en otro tipo, se necesitarán también piezas de máquina, por lo que deberá indicarse en los pedidos el tipo exacto de que se dispone y el deseado.

Equipement des sous-classes 1)  
 Unterklassen-Ausstattung 1)

Dotación de las subclases 1)  
 Subclass organization 1)

Unterklasse Subclass Sous-classe Subclase	Ausführung Model Version Tipo de maquina	Nahfuß 4 102 Presserfoot Pied presseur Pie prensatejas	Bandführung Tape guide Guide-ruban Guacintas	Bandtrommel Tape reel Tambour-derouleur Tambor portacintas	Niederhalter 107 Work retainer Pied de maintien Pie de retención	Nadelführungsbügel 102 Needle guide Enrier guide-aiguille Guia para la aguja	Fingerschutz 107 Finger guard Garde-doucis Salvadedos
-72/01-944/01	B	91-051 159-93	91-053 228-21 91-042 036-91	91-041 644-91	91-010 883-04		91-157 813-91
	B	91-051 159-93	91-053 228-21 91-042 036-91	91-041 644-91	91-010 882-04		91-157 813-91
-720/02-944/01	A	91-051 138-93			91-010 816-03		
	B	91-051 138-93			91-010 816-03		
-720/02-944/01-900/56	A	91-051 138-93			91-010 816-03		
	B	91-051 138-93			91-010 816-03		
-720/02-944/01	B/CN	91-051 138-93			91-010 816-03		
	B/CN	91-051 138-93			91-010 816-03		
-720/02-944/01-900/56	B/CN	91-051 138-93			91-010 816-03		
	B/CN	91-051 138-93			91-010 816-03		
-750/01-4/01	A	91-141 232-13			91-010 805-04 10 = 0,8 - 1,4 mm	91-012 656-04 10 = 0,8 - 1,6 mm	91-012 658-91
	B	91-141 232-13			91-010 880-04 10 = 1,6 - 2,2 mm		91-012 658-91
	B	91-141 232-13			91-010 883-04		91-012 658-91
-750/01-4/01-900/56	A	91-141 232-13			91-010 805-04 10 = 0,8 - 1,6 mm	91-012 656-04 10 = 0,8 - 1,6 mm	91-012 658-91
	B	91-141 232-13			91-010 880-04 10 = 1,8 - 2,2 mm		91-012 658-91
	A; B	91-141 232-13			91-010 882-04		91-012 658-91
-944/01	A	91-051 159-93			91-010 805-04 10 = 1,2 - 1,6 mm	91-012 656-04 10 = 1,2 - 1,6 mm	91-012 658-91
	B	91-051 159-93			91-010 880-04 10 = 1,8 - 2,2 mm		91-012 658-91
	B	91-051 159-93			91-010 882-04		91-012 658-91
-944/01-900/56	A	91-051 159-93			91-010 805-04 10 = 0,8 - 1,6 mm	91-010 806-04 10 = 0,8 - 1,6 mm	91-157 813-91
	B	91-051 159-93			91-010 883-04		91-157 813-91
	B	91-051 159-93			91-010 882-04		91-157 813-91
-944/01-900/56	A	91-051 159-93			91-010 805-04 10 = 0,8 - 1,6 mm	91-010 806-04 10 = 0,8 - 1,6 mm	91-157 813-91
	B	91-051 159-93			91-010 880-04 10 = 1,8 - 2,2 mm		91-157 813-91
	A; B	91-051 159-93			91-010 882-04		91-157 813-91
-944/01-900/56	A	91-051 159-93			91-010 805-04 10 = 1,2 - 1,6 mm	91-010 806-04 10 = 1,2 - 1,6 mm	91-157 813-91
	B	91-051 159-93			91-010 880-04 10 = 1,8 - 2,2 mm		91-157 813-91
	B	91-051 159-93			91-010 882-04 10 = 2,4 - 6,0 mm		91-157 813-91

4 = Ausführung angeben  
 = Indicate model  
 = Préciser la version  
 = Indiquese el tipo de maquina

5 = Nahmuster senden  
 = Submit sewing sample  
 = Joindre échantillons de couture  
 = Enviese muestra de costura

101 = je nach Nadelabstand ändert sich die Form (z.B. beim Stoffschieber die Anzahl der Zähnräder)  
 = Certain design features change according to the needle gauge (e.g. the number of tooth rows on the feed dog)  
 = La forme est fonction de l'écartement des aiguilles (par ex. le nombre des rangées de dents de la griffe)  
 = La forma vária de acuerdo con la distancia entre agujas (p.e. el número de hileras de dientes en el transportador)

102 = Nadelabstand bei Bestellung angeben  
 = State needle gauge on order  
 = Indiquer écartement des aiguilles à la commande  
 = Indiquese en los pedidos la distancia entre agujas

10 = Nadelabstand  
 = Needle gauge  
 = Écartement des aiguilles  
 = Distancia entre agujas

3/2/01 = Frühere Ausführung  
 = Earlier version  
 = Ancienne version  
 = Tipo anterior

\* = Nadelabstand bei Bestellung angeben  
 = Please state diagonal needle distance on order  
 = Priere d'indiquer l'espacement diagonal des aiguilles à la commande  
 = Indiquese en los pedidos la distancia diagonal entre agujas

Unterklassen-Übersicht/Table of subclasses/Table des sous-classes/Tabla de subclasses

91-012 658-91

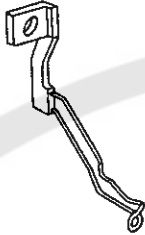

-750/01-4/01  
-750/01-4/01-900/51

11-108 222-15



11-108 222-15

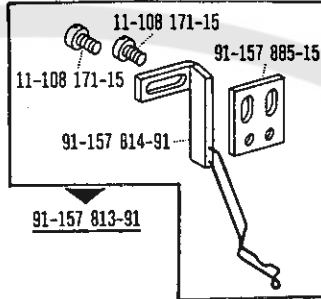

91-157 813-91

-72/01-944/01  
-944/01 (-900/56)

91-140 099-05



91-118 196-12



11-174 173-15

-72/01-944/01  
-750/01-4/01 (-900/56)  
-944/01 (-900/56)

91-140 631-91

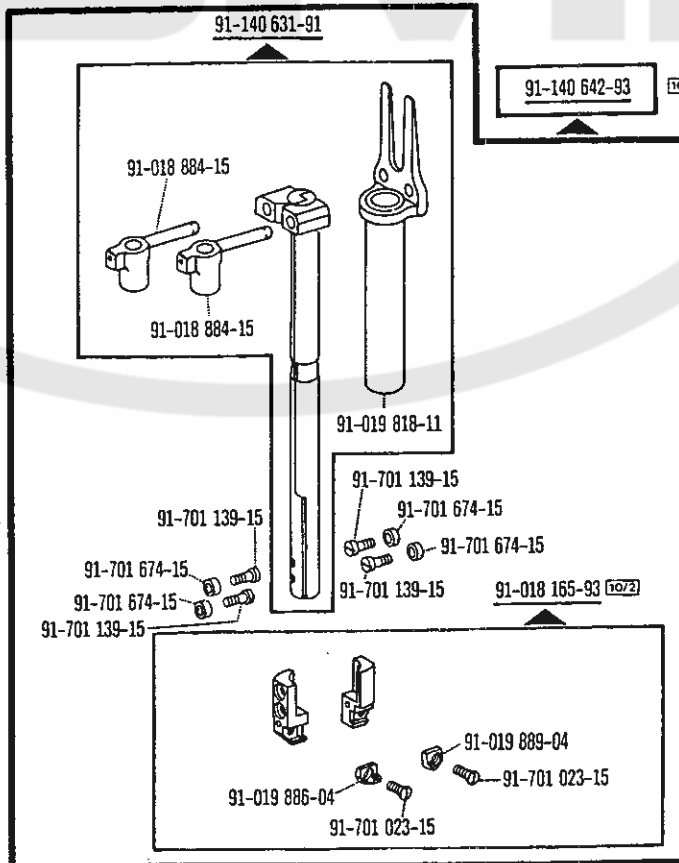

91-140 642-93

no/2

91-018 884-15



91-018 884-15

91-019 818-11



91-701 139-15

91-701 674-15

91-701 674-15

91-701 139-15

91-018 165-93 no/2

91-701 139-15

91-701 674-15

91-701 674-15

91-701 139-15

91-019 886-04

91-701 023-15

91-019 889-04

91-701 023-15

-720/02-944/01  
-720/02-944/01-900/56

Unterklassen-Übersicht/ Table of subclasses/ Table des sous-classes/ Tabla de subclasses

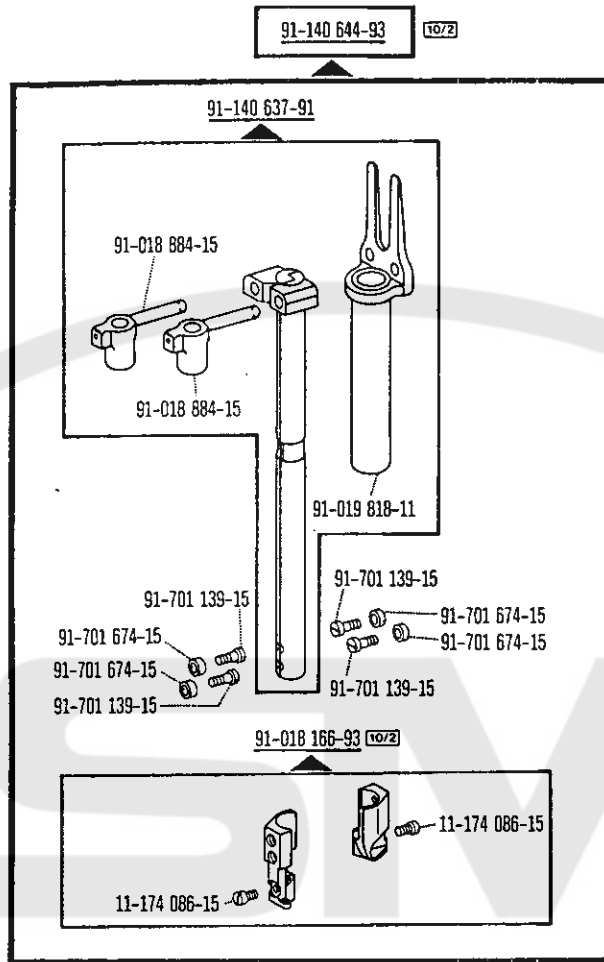

-720/02-944/01  
-720/02-944/01-900/56

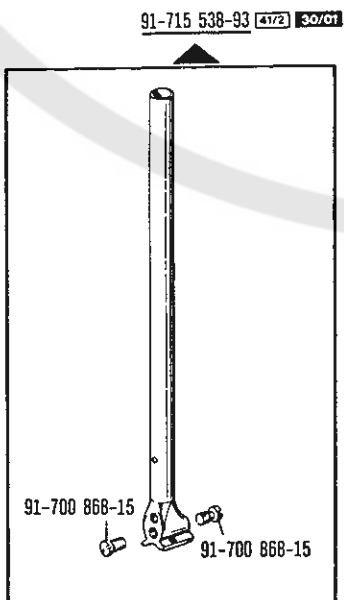

-72/01-944/01  
-944/01

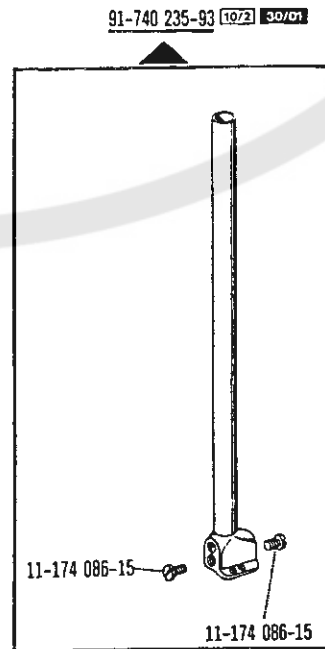

-72/01-944/01  
-944/01

Unterklassen-Übersicht/ Table of subclasses/ Table des sous-classes/ Tabla de subclasses

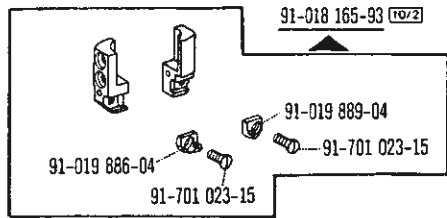

-720/02-944/01 (-900/56)

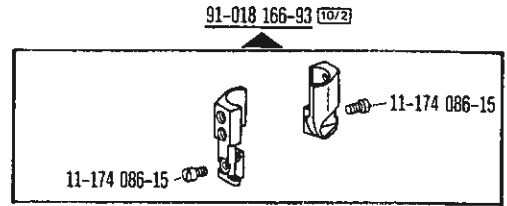

-720/02-944/01 (-900/56)

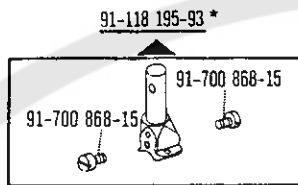

-72/01-944/01  
-750/01-4/01 (-900/56)  
-944/01 (-900/56)

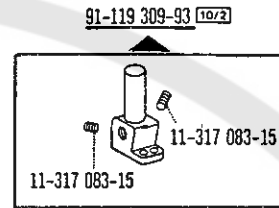

-72/01-944/01  
-750/01-4/01 (-900/56)  
-944/01 (-900/56)

91-040 358-04

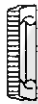

-720/02-944/01  
-944/01

91-047 025-04

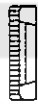

-72/01-944/01  
-720/02-944/01

91-059 210-04



-720/02-944/01 (-900/56)  
-750/01-4/01-900/56  
-944/01 (-900/56)

91-048 068-04  
10 = 0,8-2,8 mm      10 = 3,2-6,0 mm



-944/01

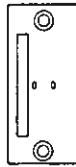

-720/02-944/01  
-944/01

91-048 212-03  
10 = 1,2-2,8 mm      10 = 3,2-4,8 mm

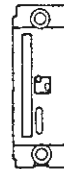

-72/01-944/01

91-048 508-04



-720/02-944/01

91-158 168-04



-944/01-900/56

91-158 170-04

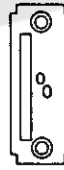

-750/01-4/01-900/56  
-944/01-900/56

91-158 172-04

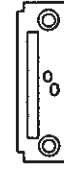

-750/01-4/01-900/56  
-944/01-900/56

91-158 173-04



-720/02-944/01-900/56  
-750/01-4/01-900/56  
-944/01-900/56

91-158 174-04

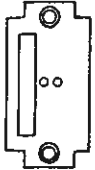

-720/02-944/01-900/56 B/CM  
-750/01-4/01-900/56  
-944/01-900/56

91-158 626-04

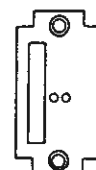







-720/02-944/01

91-051 138-93

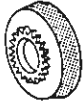
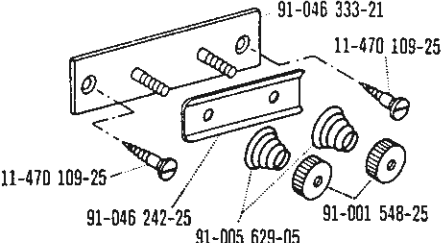

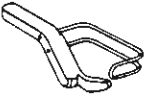
-720/02-944/01 (-900/56)

Unterklassen-Übersicht/Table of subclasses/Table des sous-classes/Tabla de subclasses

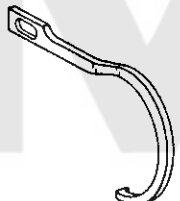
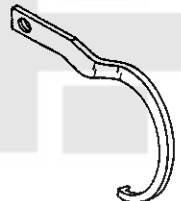
<p>91-051 159-93  </p>  <p>-72/01-944/01 -944/01 (-900/56)</p>	<p>91-141 232-13</p>  <p>-750/01-4/01 -750/01-4/01-900/56</p>	<p>91-042 036-91</p>  <p>91-046 333-21 11-470 109-25 11-470 109-25 91-046 242-25 91-005 629-05 91-001 548-25</p> <p>-72/01-944/01</p>	
<p>91-053 228-21</p>  <p>-72/01-944/01</p>	<p>91-010 805-04  </p>  <p>-750/01-4/01 (-900/56) -944/01 (-900/56)</p>	<p>91-010 816-03  </p>  <p>-720/02-944/01 -720/02-944/01-900/56</p>	<p>91-010 880-04  </p>  <p>-750/01-4/01 (-900/56) -944/01 (-900/56)</p>
<p>91-010 882-04  </p>  <p>-72/01-944/01 -750/01-4/01 (-900/56) -944/01 (-900/56)</p>	<p>91-010 883-04  </p>  <p>-72/01-944/01 -750/01-4/01 -944/01</p>	<p>91-010 806-04  </p>  <p>-944/01 (-900/56)</p>	<p>91-012 656-04  </p>  <p>-750/01-4/01 (-900/56)</p>

91-041 644-91

